

Wi-Fi HUB

Pairing-Unpairing-Factory reset

PRODUCT DETAILS	1
PRODUCT DIMENSIONS	3
IMPORTANT!!! Wall level finish and wall box mounting position:	4
A diagram of a wall with a door <small>Description automatically generated</small>	5
HUB PAIRING AND RESET	5
Ethernet Hub Pairing and Reset	6
To Pair	6
To Reset	7

PRODUCT DETAILS

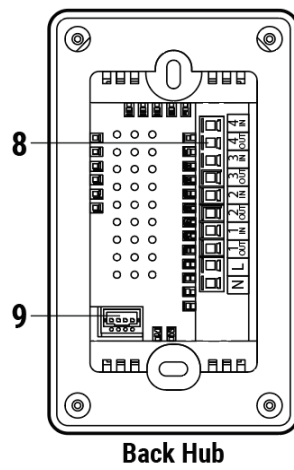
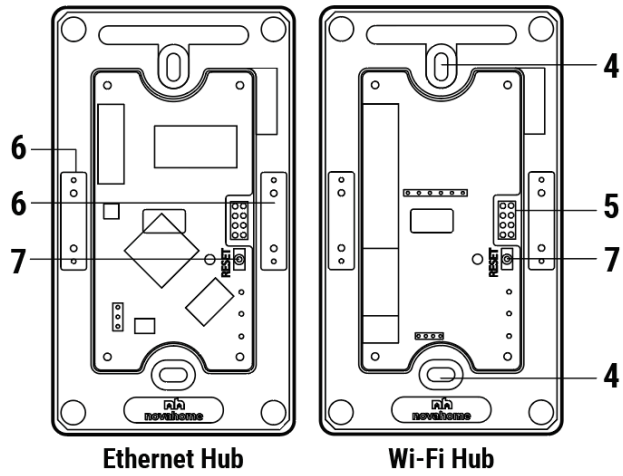
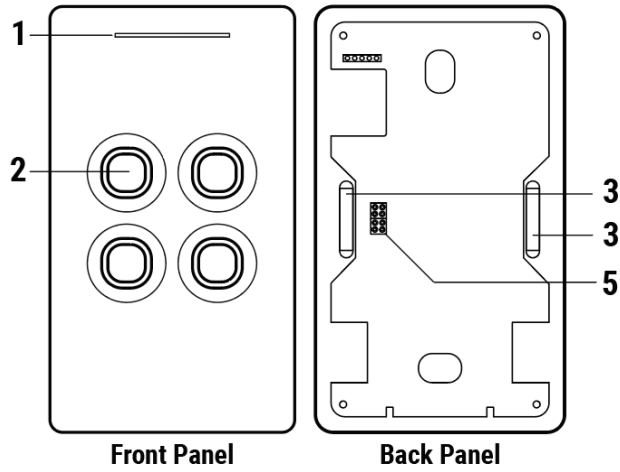

Labels:

1. Dimmable Status Led
Red - Offline
Blue - Online
2. Dimmable Touch Buttons
Red - ON
Blue - OFF/Standby
3. Magnet
4. Screw Hole
5. Pin
6. Metal Plate
7. Reset Button
8. Wire Terminal
9. Communication Port

Accessories:

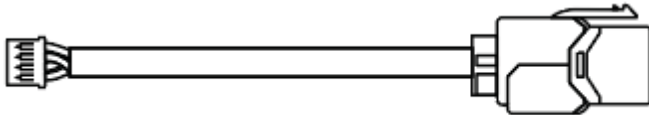

Communication Cable



Wire Connectors

PRODUCT DIMENSIONS

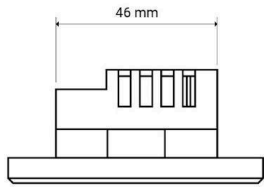

TOP VIEW

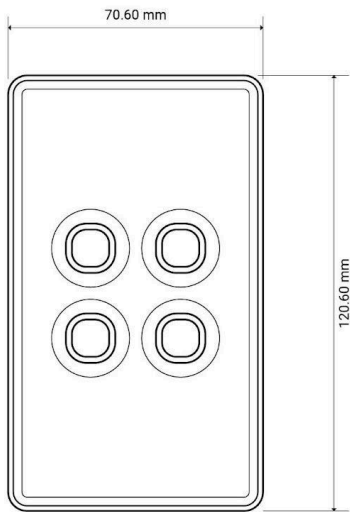

FRONT VIEW

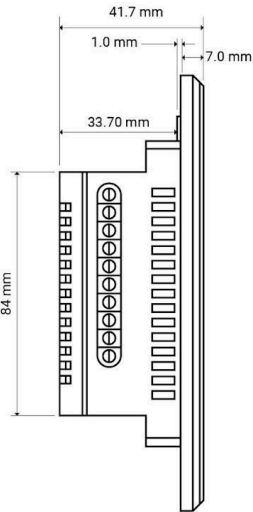

SIDE VIEW

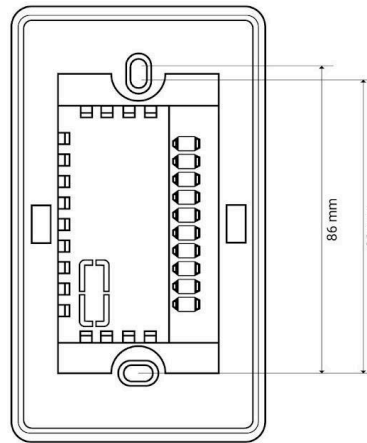

BACK VIEW

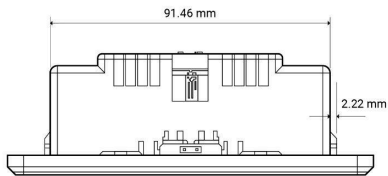

TOP VIEW

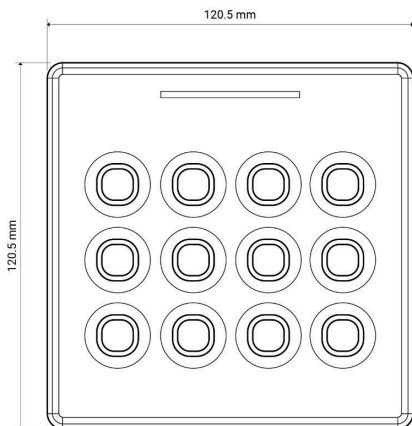

FRONT VIEW

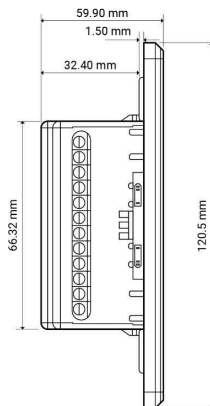

SIDE VIEW

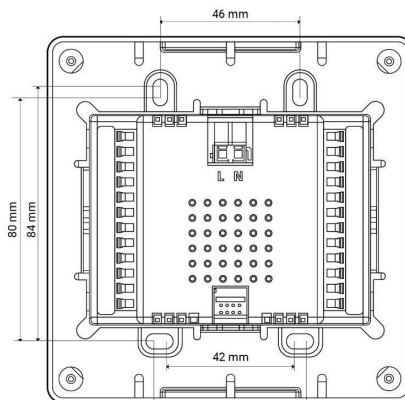

BACK VIEW

IMPORTANT!!! Wall level finish and wall box mounting position:

Wall surface where the Switchhub will be Installed needs to be evenly flat. This is to ensure that the touch panel magnetic will 100% attach properly to the surface of the Switchhub.

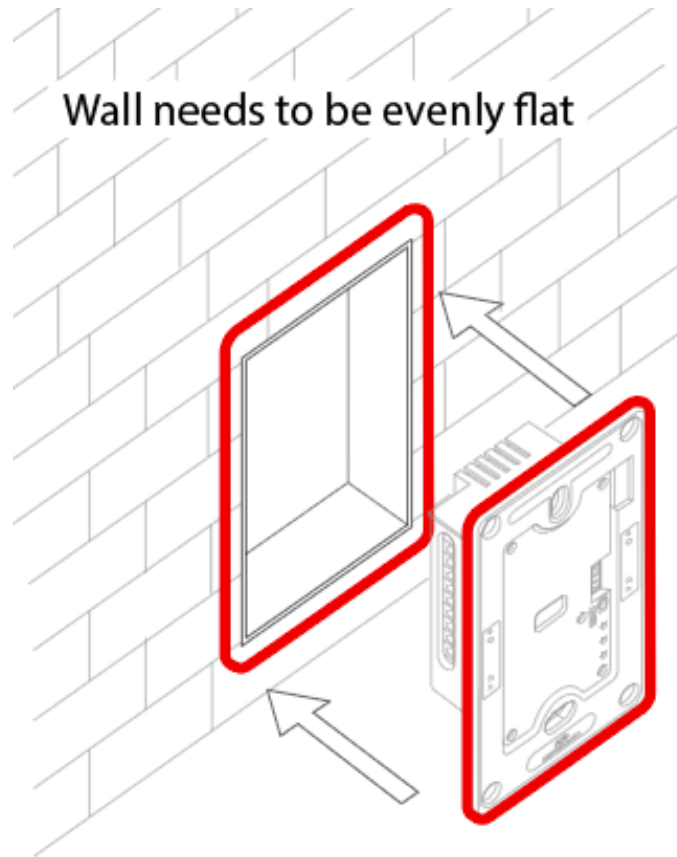

HUB PAIRING AND RESET

Wi-Fi Hub Pairing and Reset

INSTALL MOBILE APPLICATION and sign in

Please Download and install compatible Tuya APP from Google Play Store or Apple App Store.



Smart Life download link:

<https://play.google.com/store/apps/details?id=com.tuya.smartlife>
<https://apps.apple.com/ph/app/smart-life-smart-living/id1115101477>



Tuya download link:

<https://play.google.com/store/apps/details?id=com.tuya.smart>
<https://apps.apple.com/ph/app/tuya-smart/id1034649547>

To Pair

Step 1:

Detach the smart touch panel to access the hub reset button and led indicators.

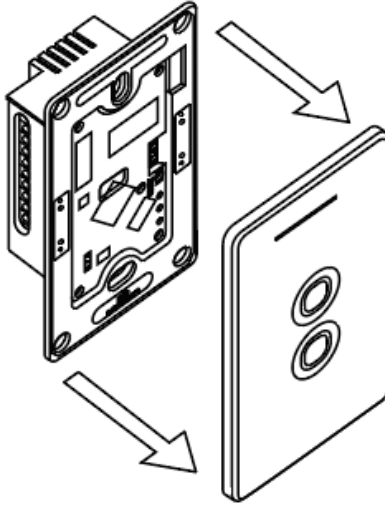

Step 2:

Wi-Fi Hub will automatically set to pairing mode when powered ON. Blue light is ON and the red light is blinking when ready to pair.

To pair to the APP, open APP:

Note: When connecting the Wi-Fi Hub, make sure that the mobile phone is connected to 2.4GHz Wi-Fi, otherwise the Wi-Fi Hub cannot be registered through the cloud, and the connection cannot be successful.

Add device -> Choose Gateway Control -> Wireless Gateway (Zigbee). Follow APP instructions.

For manual pairing, press reset and hold for 5 secs until two green lights appear.

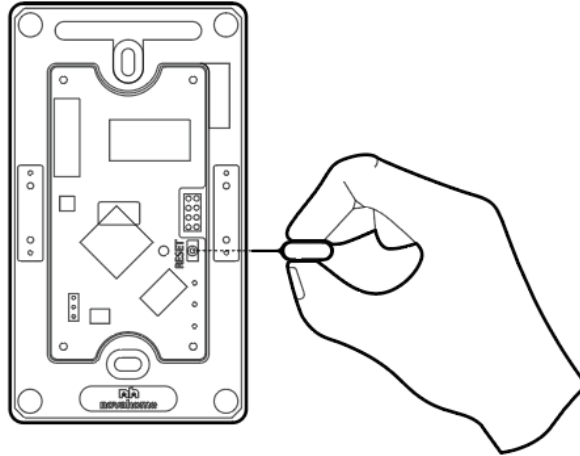

To Reset

To manually set pairing mode or to RESET press and hold reset button for 5 secs. Blue light is ON and the red light is blinking when ready to pair.