

# Ethernet HUB

## Pairing-Unpairing-Factory reset

<a href="#">PRODUCT DETAILS</a>	2
<a href="#">PRODUCT DIMENSIONS</a>	4
<a href="#">IMPORTANT!!! Wall level finish and wall box mounting position:</a>	5
<a href="#">A diagram of a wall with a door</a> <small>Description automatically generated</small>	5
<a href="#">HUB PAIRING AND RESET</a>	6
<a href="#">Ethernet Hub Pairing and Reset</a>	6
<a href="#">To Pair</a>	7
<a href="#">To Reset</a>	8

# PRODUCT DETAILS

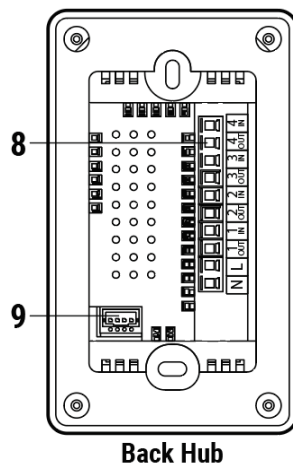
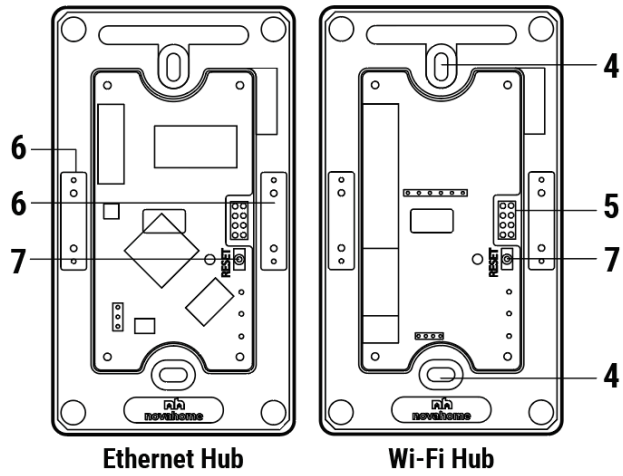
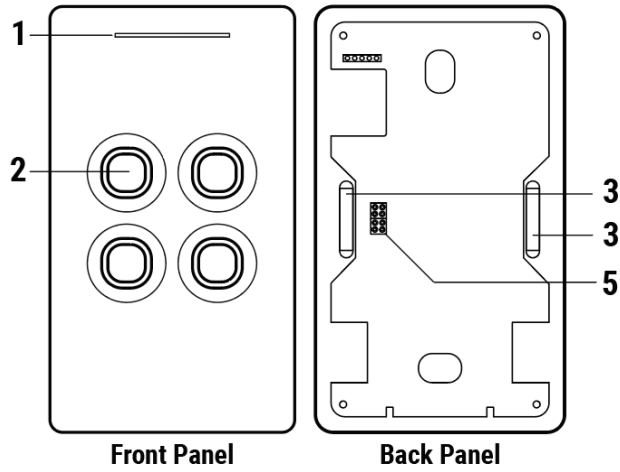

## Labels:

1. Dimmable Status Led  
Red - Offline  
Blue - Online
2. Dimmable Touch Buttons  
Red - ON  
Blue - OFF/Standby
3. Magnet
4. Screw Hole
5. Pin
6. Metal Plate
7. Reset Button
8. Wire Terminal
9. Communication Port

## Accessories:

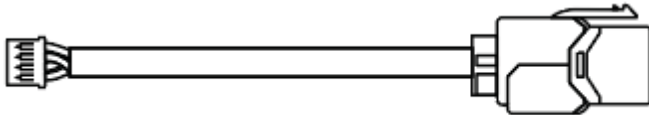

Communication Cable



Wire Connectors

# PRODUCT DIMENSIONS

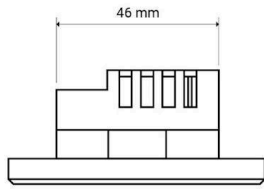

TOP VIEW

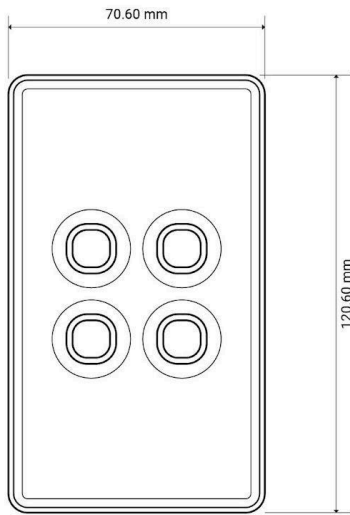

FRONT VIEW

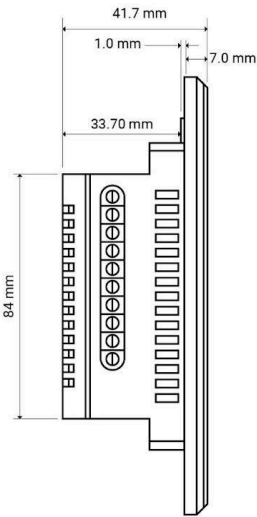

SIDE VIEW

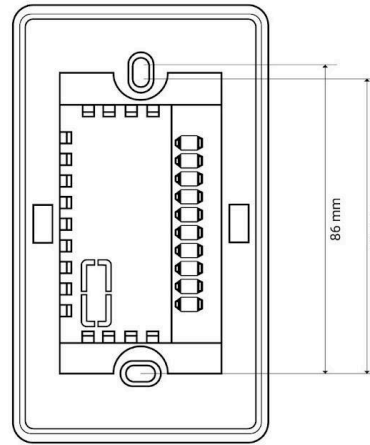

BACK VIEW

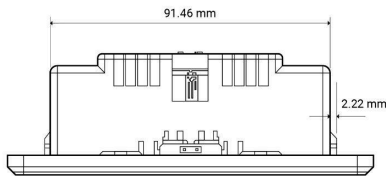

TOP VIEW

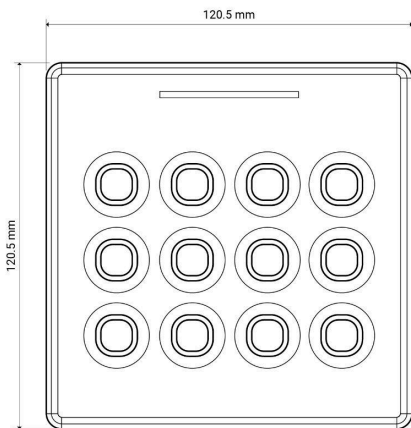

FRONT VIEW

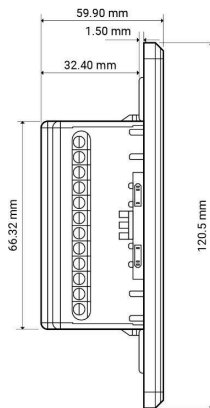

SIDE VIEW

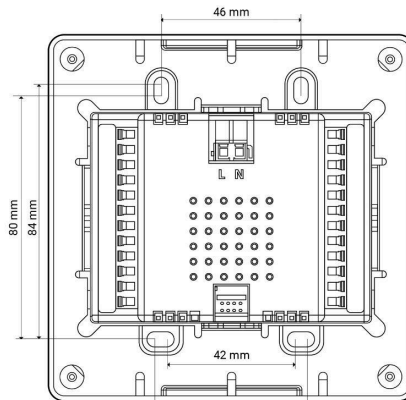

BACK VIEW

## **IMPORTANT!!! Wall level finish and wall box mounting position:**

Wall surface where the Switchhub will be Installed needs to be evenly flat. This is to ensure that the touch panel magnetic will 100% attach properly to the surface of the Switchhub.

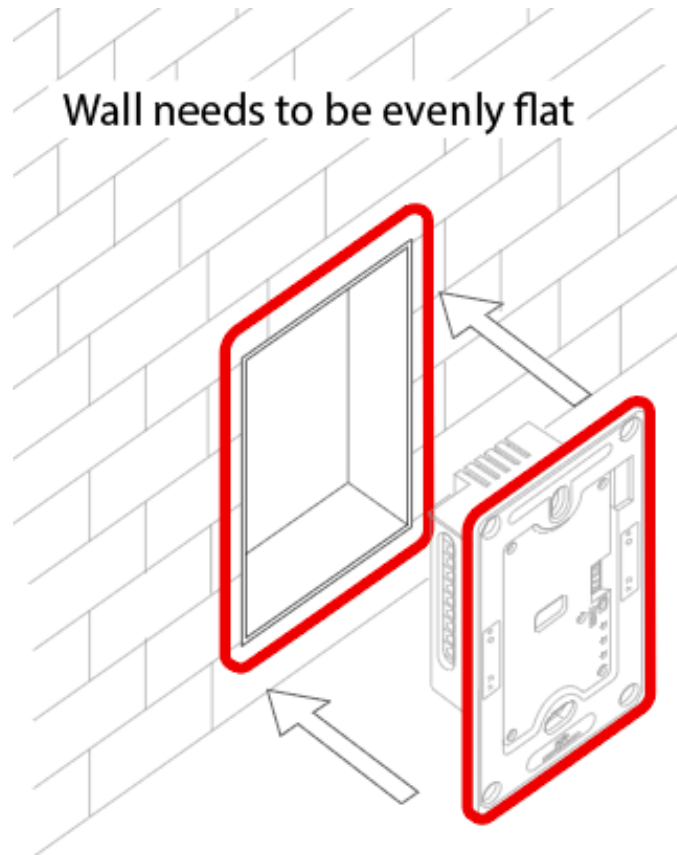

# HUB PAIRING AND RESET

## Ethernet Hub Pairing and Reset

*Note: Make sure the Switchhub LAN wire is connected to the internet Wi-Fi router LAN port.  
Please refer to wire installation instructions.*

## INSTALL MOBILE APPLICATION and sign in

Please Download and install compatible Tuya APP from Google Play Store or Apple App Store.



Smart Life download link:

<https://play.google.com/store/apps/details?id=com.tuya.smartlife>  
<https://apps.apple.com/ph/app/smart-life-smart-living/id1115101477>



Tuya download link:

<https://play.google.com/store/apps/details?id=com.tuya.smart>  
<https://apps.apple.com/ph/app/tuya-smart/id1034649547>

## To Pair

### Step 1:

Detach the smart touch panel to access the hub reset button and led indicators.

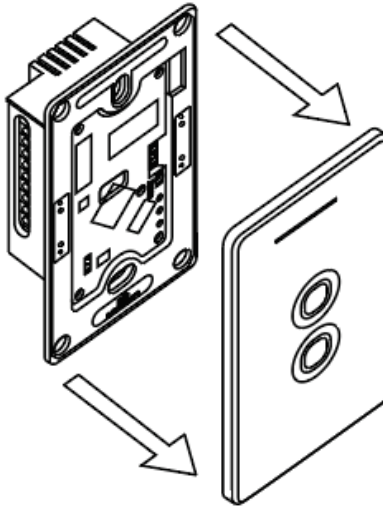

### Step 2:

Ethernet Hub will automatically set to pairing mode when powered ON. Two green lights are ON when ready to pair.

### To pair it to the APP, open APP:

Add device -> Choose Gateway Control -> Gateway (Zigbee). Follow APP instructions. For manual pairing, press reset and hold for 5 secs until blue light is ON and red light is flashing.

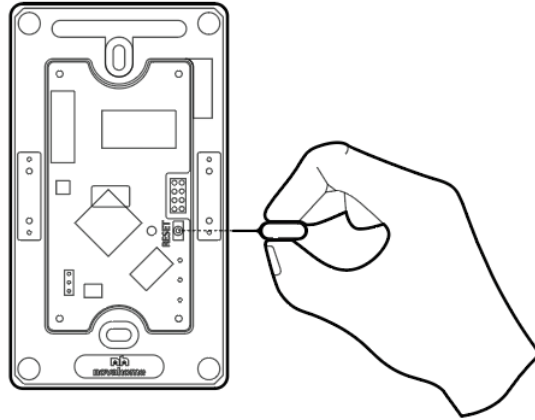

## To Reset

To manually set pairing mode or to RESET press and hold reset button for 5 secs until two green lights are ON and ready to pair.